

Model #: \_\_\_\_\_

Serial #: \_\_\_\_\_



## Instruction Manual for HI-Series Mixer

(SM-100, SM-100/nh, SM-200-B, SM-200/nh, SM-30HI, SM-40HI, SM-60HI,  
SM-A80HI, SM-B80HI)

### **SMAKY AB**

Regulatorvägen 21, S-141 49 Huddinge, Sweden

Tel+ 46 8 657 9490

Fax+ 46 8 657 8980

<http://www.smakymixers.com>

e-mail: info@smaky.com

## **CONTENTS**

Before operation	.....P.1
Overall View of the Mixer	.....P. 2
Installation Instructions	.....P.3-4
Operating Instructions	.....P. 4-8
Cleaning Instructions	..... P. 9
Maintenance	.....P. 9-10
Troubleshooting	..... P.11
Limited Warranty	..... P.12
Capacity Chart Table	.....P.13-14

## **CAUTION**

## **Read before you operate the machine**

It is important to read this manual and following the instructions before operating the machines. This mixer is designed as a safe and efficient food processing product as long as the machine is used in accordance with the instructions in this manual and is properly maintained.

User has taken following precautions in order to operate the mixer safely.

- **All operators should be at least 18 years old and are adequately trained and supervised. Also, have fully read and understood this manual.**
- **Owner should not let customer, visitor or other unauthorized people come in contact with this machine.**
- **Do not wear loose clothes or ring while operating, and keep hands, hair and clothing away the moving parts.**
- **NEVER use an extension cord to connect to electrical power.**
- **Make sure the safety guard is closed and bowl is lifted to upright position before operating.**
- **NEVER reach into the bowl when the mixer is running.**
- **NEVER place your hand or any kitchen utensil in the bowl whilst the mixer is in operation.**
- **When mixing products, always follow the recommended agitator and speed settings according to the capacity chart provided in this manual.**
- **STOP the mixer before changing speed.**
- **STOP the mixer before removing or installing attachments onto the hub.**
- **NEVER put your hand and finger into the feed chute when using any mixer attachment, include VH-12 Meat Mincer and V99S Vegetable Slicer.**  
**Always use the pusher plate with attachment.**
- **Always UNPLUG before cleaning or doing any maintenances.**
- **DO NOT hose down or pressure wash any part of the mixer.**
- **NEVER bypass, alter or modify this machine. Doing so may create hazard and will void warranty.**

**If you have any questions, please contact any local representative or SMAKY directly.**

# Overall View of the Mixer

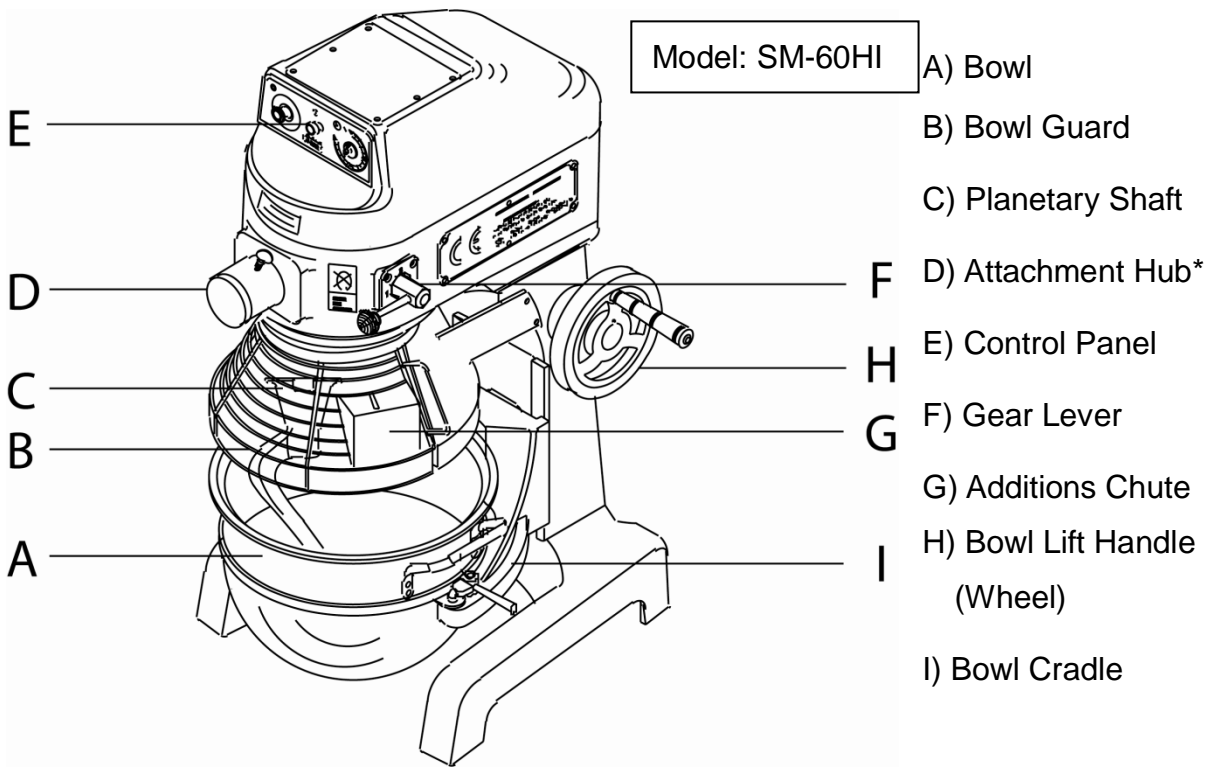

**NOTE:** Attachment Hub is optional.

## Control Panel

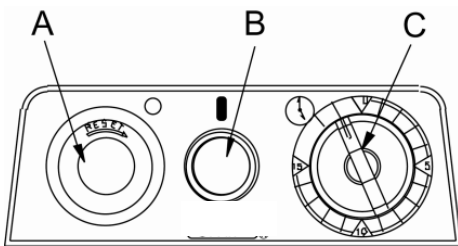

- A) Emergency Stop
- B) Start
- C) Timer\*\*

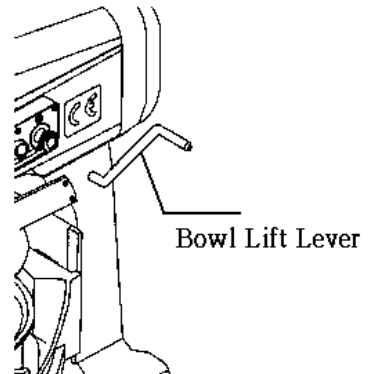

**NOTE:** Timer is optional on Model SM-100/nh, SM-200-B and SM-200/nh.

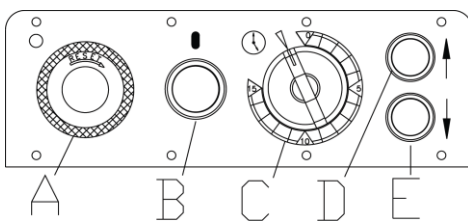

- D) Bowl Raise Button
- E) Bowl Lower Button  
(Available for SM-A80HI only)

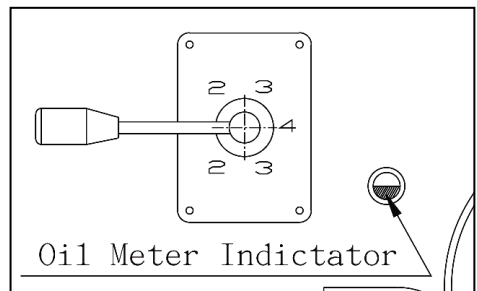

**NOTE:** Oil Meter Indicator is only available for SM-A80HI, SM-B80HI.

# Installation Instructions

## **INSTALLATION MUST BE CARRIED OUT BY QUALIFIED TECHNICIAN**

- The machine is supplied factory lubricated and ready to run. It should be positioned on a solid, level and non-skid work surface that is nonflammable. Install in work area with adequate light and space.
- For SM- 200 or smaller capacity models, you may place the mixer on bench which is capable of supporting a load of mixer's weight. For safety, the mixer should be **BOLTED** in position using all four holes located in the legs.
- DO NOT attempt to lift the mixer alone.
- Clean the mixer before use. It is normal for the factory to apply a generous amount of grease in and on the machine before initial use.
- During the transportation or fitting, please do not lean over 35 degree to avoid the gear oil leaking from the gear oil container.
- Please use forklift to transporting. Please refer to **Figure 1**.

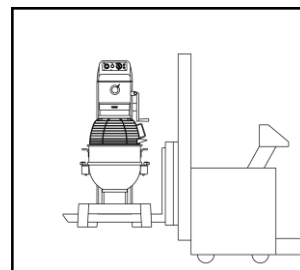

**Figure 1**

## **ELECTRICAL CONNECTION MUST BE MADE BY QUALIFIED ELECTRICIAN**

**CAUTION: NEVER USE AN EXTENSION CORD.** Low amp supply could damage the mixer or cause a fire.

Before connecting this machine to the electrical supply, check that the details on the rating plate (located on the rear of the machine) correspond to the details of your electrical connection.

The mixer is supplied with a trailing lead fitted with a molded plug. If the style of plug is unsuitable for the socket you plan to use, the plug must be cut off and replaced with an appropriate plug.

Machines are fitted with a color coded three core cable as follows:

- (1) Brown: Live
- (2) Blue: Neutral
- (3) Green/Yellow: Earth

As the color of the wires may not correspond to the colored markings identifying the terminals in your plug, you should proceed as follows:

- The wire which is colored blue must be connected to the terminal which is marked with the letter N or colored black.
- The wire which is colored brown must be connected to the terminal which is marked with the letter L or colored red.
- The wire which is colored green/yellow must be connected to the terminal which is marked with the letter E or colored green.

**NOTE:** In terms of the **3-phase**, when the mixer is located and connected with the plug, **please make sure that the shaft goes clockwise.** (Same direction as the arrow sticker that is located on the front of the machine) If the shaft goes counterclockwise, please replace the wires: R.S.T. (USA) L1, L2, L3, (Europe). To replace the wires each other until the shaft goes clockwise.

## Installation Instructions

The mixer should be plugged into a switched socket which isolates all poles and has a minimum contact clearance of 3mm and located close to the mixer for use in an emergency and to facilitate servicing.

The machine must be incorporated into a potential equalization system.

The leakage current for this appliance is no greater than 1 mA/KW.

If the electrical supply cable to the machine becomes damaged, it must be replaced by a specification or higher and suitable for the Mixer's motor load.

**The ground wire is fixed to the machine and this connection must be kept intact.**

**CAUTION: The mixer MUST be grounded.**

- The minimum requirement for all electrical equipment is correct operation between air temperature of +5 ° C and +40 ° C.
- Electrical equipment is capable of operating correctly when the relative humidity does not exceeding 95% at a maximum temperature of +40 ° C.
- Electrical equipment is capable of operating correctly at altitude up to 1000m.
- Electrical equipment is designed to withstand to protected against the effects of transportation, and storage temperature within a range of -25 ° C to +55 ° C and for short periods not exceeding 24h at up to +70 ° C.

## Operating Instructions

### **BEFORE USING THE MIXER**

Before using the mixer, ensure that all users are familiar with the correct operation of the machine. In particular, care should be taken to ensure that the bowl and mixing tools are correctly fitted and that the bowl guard is in position prior to starting the machine.

### **SAFETY AT WORK**

- NEVER place your hand or any kitchen utensil in the bowl whilst the mixer is in operation.
- Keep hands, hair and clothing away from moving parts.
- Isolate the machine from the electrical supply by removing the plug from the socket before cleaning, servicing or adjusting any parts or attachments.
- Do not use the machine with any cover or guard removed.
- Certain operator notice advising about the safe use of this mixer is attached to the machine.

### **OFFICE, SHOPS AND RAILWAY PREMISES ACT, 1963**

The above Act requires that this machine and attachments shall be operated only by a properly instructed person or by an employee who is under the supervision of a properly instructed person. The instruction shall include indication of the possible dangers arising and the precautions to be observed. The Act also requires that no person under the age of 18 shall clean a machine if this exposes him to risk of injury from a moving part of that machine or any adjacent machine.

# Operating Instructions

## **CORRECT USE OF THE MIXER**



- It is the responsibility of the operators to use the mixer correctly within the recommended limitations. Always follow the instructions on the side of the machine when changing gear. If the motor labors, please stop the machine and reduce the size of the mix immediately. Damage resulting from improper use is will void the warranty.
- For operator safety, the machine is fitted with a bowl guard which is electrically interlocker to ensure that the mixer cannot operate unless the guard is correctly positioned and the bowl is raised. Excessive force used to open and close the bowl guard may damage the electrically interlocker, and will void the warranty.
- For additional safety, the mixer has a no volt release feature which means that in the event of a power failure, the machine will only restart after the control button has been pressed again. This arrangement ensures that when the supply is restored, the machine cannot restart on its own.
- Careful handling of bagged products by minimizing the height above the bowl base from which they are poured.
- Careful slitting of bags in the lower part of the bowl to allow dust free discharge of flour as flour as possible.
- Use temporary bowl covers to minimize openings through which flour may escape.

## **TOOL SELECTION**

The beater, whisk and spiral dough hook are tools for the work implied by their names. Do not use the beater for dough making or the whisk for anything other than whisking, aerating or mixing light mixtures.

The **Table 1** shows the typical uses for each of the tools.

**NOTE: Always wash agitator with mild soap and apply light quantity of mineral oil to planetary shaft after cleaning.**

	<b>Beater:</b> Firm mixes such as light pastry, cakes biscuits, icings fillings and mashed vegetables.
	<b>Spiral Dough Hook:</b> Heavy mixes such as dough, pie pastry. .
	<b>Whisk:</b> Light mixes such as whipped cream, mayonnaise, egg whites, pancakes and soufflés.

**Table 1**

## **FITTING THE BOWL**

With the bowl cradle lowered, place the chosen mixing tool in the bowl and position the bowl on the cradle. There are three location points when fitting the bowl. Please refer to **Figure 2**:

- (1) The locking pin at the rear of the bowl should locate in the hole of the cradle.
- (2) The two holes in the bowl handles must engage on the pins located on the cradle.
- (3) Please ensure that the bowl is seated correctly on the cradle before securing the bowl locking latches prior to use.

**(For Bigger Capacity Mixer, above 60qt)NOTE: Please use bowl truck to load and unload bowl containing more than 50lbs per batch.**

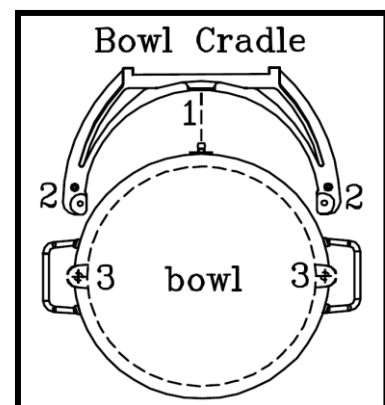

**Figure 2**

# Operating Instructions

## FITTING THE MIXING TOOL

Slide the bayonet fitting of the agitator onto the drive shaft and twist clockwise to secure it in position. To remove the agitator, slide the tool up the shaft slightly and twist counter clockwise. Please refer to **Figure 3**.

**NOTE:** Install the bowl **BEFORE** inserting agitators.

**NOTE:** Agitators should always rotate in a clockwise direction around bowl. If agitators move counterclockwise, please contact licensed electrician immediately to remedy incorrect wiring.

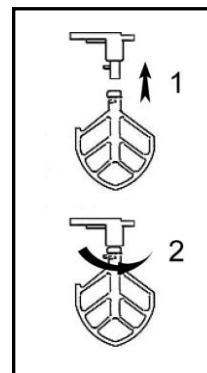

Figure 3

## BOWL LIFT & BOWL GUARD

The bowl cradle and bowl guard are electrically interlocked so that the machine will only operate with the bowl cradle at the raised position. In addition to this, the bowl guard must be locked into place by sliding it into position across the top of the bowl to the point where it will slide no further.

**NOTE:** Only once the bowl is raised and the bowl guard locked, the machine can operate. Thus ensuring total user safety at all times. Once the guard has been opened or the bowl lowered, the machine will stop immediately. The Mixer can only be restarted by pressing the start button again.

During the mixing process, additional ingredients can be added by the chute located on the right hand side of the bowl guard.

## CONTROLS

The **Timer (C)** is arranged to automatically stop the machine after the selected interval. An untimed position is provided for manually controlled mixing cycles.

Before starting the mixer it is necessary to set the mixing duration or select the manual position – the mixer will not operate in the 0 position.

### **TIMED OPERATION**

For timed operation turn the **Timer Knob (C)** to the desired time (duration is marked from 1 to 15 in graduations of one minute) and then press the **Green Start Button (B)** to start the mixer. After the timed period you set, the mixer will stop automatically. If it is necessary to stop the mixer before the end of the timed period, press the **Red Stop Button (A)**. Timer available on models SM-100/nh, SM-200-B, SM-200/nh

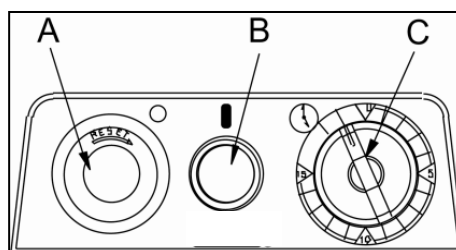

### **UNTIMED OPERATION**

If you wish to manually control a mix, select the untimed mode by moving the Timer Knob anti-clockwise to the green mark until it stops.

# Operating Instructions

## **POWER BOWL LIFT**

**NOTE:** Power Bowl Lift is only available for Model SM-A80HI.

Powered by an electric motor, the bowl may be raised or lowered by fingertip control through the conveniently located switch. Please press **(D) Bowl Raise Button** to raise the Bowl Cradle. You can lower the Bowl Cradle by pressing **(E) Bowl Lower Button**.

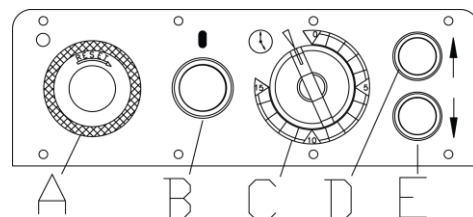

## **CAPACITY**

Please refer to Page 13. The table shows the recommended capacities of finished weights of regular mixes. Although the machine may be capable of mixing larger quantities, it will lead to excessive and premature wear and possible failure. Overloading also results in lengthy processes and unsatisfactory results.

**NOTE:** Reduce batch size by 10%, if chilled flour, water below 20 °C, ice, or high gluten flour is being used.

**NOTE:** Overloading or not following the chart will damage the mixer and void the warranty.

## **SPEED SELECTION**

Before changing speeds, the mixer must always be STOPPED first. The necessary speed can then be selected before restarting the machine by pressing the Green Start Button.

**NOTE:** The Model SM-A80HI, SM-B80HI will automatically shut off if the speed is changed during operation.

The speed selected depends largely on the quantity and consistency of the product. It is recommended that mixing is always started at the lowest speed and progressively increased to the desired setting. In an emergency situation always use the Red Emergency Stop Button to stop the machine. **Table 2** shows the recommended speeds for the range of tools. For Model SM-A80HI, SM-B80HI, please refer to **Table 3**.

Recommended speed			
	1 <sup>st</sup> Speed	2 <sup>nd</sup> Speed	3 <sup>rd</sup> Speed
Whisk	→		
Beater	→		
Hook	→		

**Table 2**

Recommended Speed				
	1 <sup>st</sup> Speed	2 <sup>nd</sup> Speed	3 <sup>rd</sup> Speed	4 <sup>th</sup> Speed
Whisk	→			
Beater	→			
Hook	→			

**Table 3**

**IMPORTANT:** When mixing products always follow the recommended agitator and speed setting.

The mixer is equipped with a motor overload protection. If the mixer shuts off during operation, reduce the batch size and **wait 2 minutes. Press the stop button then press the start button.**

For heavier loads, the mixer should not run longer than 15 minutes without pausing for a cool down period of at least 15 minutes or more before resuming mixer. For lighter loads the mixer should not run longer than 30 minutes without pausing for a cool down period of at least 30 minutes or more before resuming mixer.



# Operating Instructions

## ATTACHMENTS

**NOTE:** Attachment Hub is optional.

The ranges of attachments that can be operated from the Attachment Hub are listed below. When using an attachment, lubricate the **Drive Stud (D)** using a food quality grease or oil. To fix to the mixer refer to **Figure 4**. Release the **Thumbscrew (G)** and slide the shaft of the attachment into the hub ensuring that the **Drive Stud (D)** engages in the socket within the hub. Rotate the attachment to line up the **Location Peg (E)** with its mating hole in the hub and push firmly home. Tighten thumbscrew to secure.

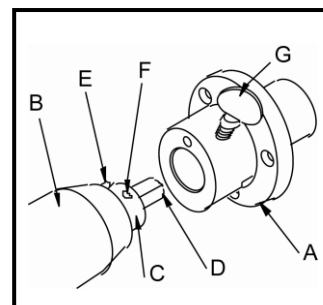
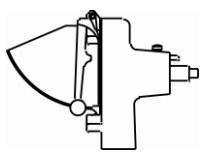
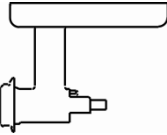

Figure 4

**CAUTION:** Only fit attachments when the mixer is stationary and never when it is operating. Do not use attachments when mixing.

The recommended speed range for some of the attachments available is shown in table below.

Recommended speed			
	1 <sup>st</sup> gear	2 <sup>nd</sup> gear	3 <sup>rd</sup> gear
V99S Veg. Prep.	→	→	
VH-12 Mincer	→	→	
	<b>V99S</b> Vegetable Preparation With a range of 8 plates to slice, grate or shred all types of vegetable and fruit from nuts and cabbage to carrots and cheese.		
			<b>VH-12 Mincer</b> A no.12 mincing attachment which works wonders with meat, fish and vegetables alike.

**NOTE:** Make sure the bowl is up and the bowl guard is closed, otherwise the mixer will not function.

**NOTE:** If you still don't understand or have any doubt of operation, please don't use the machine and contact SMAKY or the local representative.

## NOISE TEST REPORT

The average A-weighted sound pressure level is listed as below table.

**“Uncertainty, K in decibels: 4.0 dB (A) according to EN ISO 4871”**

Model	SM-100/nh	SM-200/nh	SM-30HI	SM-40HI	SM-60HI	SM-A80HI, SM-B80HI,
Noise Level	67.3 dB	65.5 dB	64.4 dB	61.9 dB	60.1 dB	59.1 dB

# Cleaning Instructions

## CARE OF YOUR MIXER

**CAUTION: ALWAYS DISCONNECT OR UNPLUG THE ELECTRICAL POWER FROM THE MIXER BEFORE CLEANING.**

The mixer is designed for simple maintenance carried out by operators. It may be necessary from time to time to apply a little Vaseline and oil to the rods on which the bowl cradle slides. If so, use a little food quality lubricant, ensuring that there is no excess oil that could contaminate the food mix.

Clean the mixer thoroughly after use. After isolating the machine from the electricity supply, the body should be wiped down with a damp cloth. **Do not spray the machine with or immerse it in water.** Do not forget to clean the rear of the machine and **do not allow the rear vents to become blocked as this may result in overheating.**

Pay particular attention to the bowl pins and any surrounding areas of the cradle to prevent the accumulation of mix, as this could prevent correct location of the bowl. For the same reason ensure that the beater shaft and each of the sockets on the tools are cleaned thoroughly. The bowl and tools should be washed in hot soapy water, rinsed and dried before being put into storage. **Do not wash the agitator s in a dishwasher, as the polished finish will be adversely affected by the dishwashing chemicals.**

# Maintenance

**It is recommended that any servicing or maintenance work must be carried out by a trained technician or electrician.**

**CAUTION: ALWAYS DISCONNECT OR UNPLUG THE ELECTRICAL POWER FROM THE MIXER BEFORE DOING MAINTENANCE.**

## MAINTENANCE

Regular maintenance is necessary on all machines if they are to remain in good working condition. It is strongly recommended that all maintenance must be carried out by trained technicians from an appointed distributor.

### ***ON A REGULAR BASIS***

Clean the machine thoroughly after use and lubricate the rods with Vaseline or lubrication oil which the bowl cradle slides. After cleaning the beater shaft, please wipe and lightly lubricate the beater shaft with Vaseline to prevent rusting. (SEE CARE ON YOUR MIXER)

### ***ON AN ANNUAL BASIS\****

Check that all bolts are tight and bowl guard secure.

- ※ Carry out on a more frequent basis if machine is arduously used.
- ※ After replacing the parts by technicians, please screw back tightly with anti-leaking coat to avoid the gear oil leaking after replacement.
- ※ Do not insert any object into the air vent of motor or into the bowl.
- ※ Please unplug while not using the mixer.

# Maintenance

## GEAR OIL METER

**NOTE:** Oil Meter Indicator is only available for SM-A80HI, SM-B80HI.

Use the gear oil to lubricate the mixer and to prolong the life of the mixer. Before using the mixer, please check the gear oil meter. When the indicator of gear oil meter is above the half of the red circle, the gear oil is full. **Please re fill the gear oil when the indicator is below the red circle.**

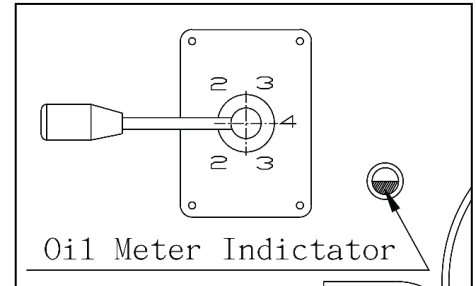

## GEAR OIL RENEWAL

**CAUTION:** Please use Mobil lubricant “UBE HD 85W-140” to refill the gearbox of model SM-A80HI, SM-B80HI.

Please unscrew and leak the oil from the indicated oil-leaking hole. After finishing the leaking, re-screw back tightly with the anti-leaking coat on the screw. Fill the gear oil to the indicated re-fill oil hole. We recommended that this servicing or maintenance work must be carried out by trained technicians from a SMAKY appointed distributor.

## GEARBOX LUBRICANT

In terms of the rest model from SM-100 to SM-60HI, please refill the lubricant inside the gearbox every 5 years. We recommended that this servicing or maintenance work must be carried out by trained technicians from a SMAKY appointed distributor.

**CAUTION:** Please use either Mobil lubricant “XHP 222” or Brugarolas “GRASA AGUILA PLEX 2-BOLSA” to refill the gearbox of model SM-100/nh, SM-200-B, SM-200/nh, SM-30HI, SM-40HI, SM-60HI.

## PLANETARY UNIT LUBRICANT

Please add **only** 2 pumps of grease to the planetary grease fitting once a year. In case there is a strange noise coming from the planetary unit, please reapply grease to the planetary unit by using the grease gun. We recommended that this servicing or maintenance work must be carried out by trained technicians from a SMAKY appointed distributor.

**CAUTION:** Please use TACBECON grease “GL-210” to lubricate the planetary unit.

# Troubleshooting

FAULT	CHECK	POSSIBLE REASON AND ACTION REQUIRED
No power to mixer	<ol style="list-style-type: none"> <li>1. Check plug socket</li> <li>2. Check wiring in plug</li> <li>3. Check fuse in plug</li> <li>4. Check or change cable</li> <li>5. Check microswitch</li> <li>6. Check circuit breaker over load or short</li> </ol>	<ol style="list-style-type: none"> <li>1. Mixer not plugged into a live socket or not switched on</li> <li>2. Plug incorrectly wired – rewire correctly</li> <li>3. Possible faulty fuse – replace fuse</li> <li>4. Cable damaged or split – replace cable</li> <li>5. Limit switch damaged or faulty – replace switch</li> <li>6. Circuit breaker shut off or constantly short – reset or replace the circuit breaker (automatically reset).</li> </ol>
Mixer falls to operate	<ol style="list-style-type: none"> <li>1. Check bowl guard/lift</li> <li>2. Check timer position</li> <li>3. Check transmission belt</li> <li>4. Check gear change lever</li> </ol>	<ol style="list-style-type: none"> <li>1. Machine will not operate with guards open</li> <li>2. Mixer will operate on timer or manual position only.</li> <li>3. Belt damaged or broken-replace belt</li> <li>4. Machine will not operate if out of gear-put in gear</li> </ol>
Mixer becomes noisy	<ol style="list-style-type: none"> <li>1. Check bowl and tools</li> <li>2. Check work surface</li> <li>3. Check bearing for wear</li> <li>4. Check gearbox</li> <li>5. Check planetary unit</li> </ol>	<ol style="list-style-type: none"> <li>1. Ensure that bowl and tool are correctly seated.</li> <li>2. Uneven surfaces create excessive resonance.</li> <li>3. Worn bearings – replace bearings</li> <li>4. Damaged or faulty gearbox – replace gearbox</li> <li>5. Reapply high-pressure grease thought grease fitting. (Please refer to MIANTENANCE)</li> </ol>
Mixer loses power	<ol style="list-style-type: none"> <li>1. Check capacity</li> <li>2. Check transmission gear</li> <li>3. Check shaft bias</li> </ol>	<ol style="list-style-type: none"> <li>1. Overloading of bowl – reduce load</li> <li>2. Gear damaged or worn – replace belt</li> <li>3. Damaged or faulty gearbox – replace shaft bias</li> </ol>
Motor overheating	<ol style="list-style-type: none"> <li>1. Check capacity/speed</li> <li>2. Check supply voltage</li> </ol>	<ol style="list-style-type: none"> <li>1. Refer to Table 2 and 3 for details</li> <li>2. Voltage should correspond to rating plate</li> </ol>
Oil on planetary shaft	Check oil seal	Worn oil seal – change oil seal
Mixing tools stuck on planetary shaft	Check planetary shaft bent, unclean or rusted.	<ol style="list-style-type: none"> <li>1. Planetary shaft twisted or bent – please change planetary shaft.</li> <li>2. Planetary shaft rusted – please use descaler for derusting.</li> <li>3. Turn planetary shaft anti-clockwise to meet square groove, gently knock down mixing tools.</li> </ol>

Ⓢ It is recommended that any servicing or maintenance work must be carried out by a trained technician or electrician.

Ⓢ solate the mixer from the electricity supply by removing the plug from the socket before cleaning or servicing.

Ⓢ solate the mixer from the electricity supply by removing the plug from the socket after long period of no use.

## Limited Warranty

### **GUARANTEE**

SMAKY provides one year guarantee from the date of purchase from one of our approved distributors. We will replace any defected parts resulted from faulty, material or workmanship, provided that no alteration, addition or repair has been carried out and provided that parts are returned to SMAKY postage paid.

### **WARRANTY**

SMAKY also provides a total of 3 year warranty on the transmission from the date of purchase, provided that no alterations, additions or repair has been carried out and provided that parts are returned to SMAKY postage paid.

Guarantee and warranty become void if the mixer has been installed incorrectly, used incorrectly and if repairs, modifications and alterations have been carried out without notifying SMAKY or SMAKY's authorized dealer.

Product	Agitator and Speed	SM-100/nh	SM-200B SM-200/nh	SM-30HI	SM-40HI	SM-60HI	SM-A80HI, SM-B80HI,
Waffle, Hot Cake Batter	Beater	4,7 lit.	7,6 lit.	11,4 lit.	15,1 lit.	22,7 lit.	28,4 lit.
Whipped Cream	Whip	1,9 lit.	3,8 lit.	5,7 lit.	8,5 lit.	11,4 lit.	15,1 lit.
Mashed Potatoes	Beater	3,6 Kg.	6,8 Kg.	10,4 Kg.	13,6 Kg	18,1 Kg	22,7 Kg
Egg Whites	Whip	0,47 lit.	0,95 lit.	1,2 lit.	1,7 lit.	1,9 lit.	1,9 lit.
Meringue (Water qt)	Whip	0,35 lit.	0,71 lit.	0,95 lit.	1,2 lit.	1,7 lit.	2,8 lit.
Raised Donut Dough (65% AR) * ◆	Hook 1 <sup>st</sup> & 2 <sup>nd</sup>	2 Kg	4,1 Kg	6,8 Kg	11,3 Kg	27,2 Kg	32,3 Kg.
Heavy Bread Dough (55% AR) * • ◆	Hook 1 <sup>st</sup> only	3,4 Kg	6,8 Kg	13,6 Kg	18,1 Kg	31,8 Kg.	32,3 Kg.
Bread and Roll Dough (60% AR) * • ◆	Hook 1 <sup>st</sup> only	5,7 Kg.	11,3 Kg	20,4 Kg	27,2 Kg.	36,3 Kg	40,8 Kg
Pizza Dough, Thin (40% AR) * • △◆□	Hook 1 <sup>st</sup> only	2,3 Kg	4,1 Kg	7,3 Kg	13,6 Kg	18,1 Kg	22,7 Kg
Pizza Dough, Medium (50% AR) * • ◆□	Hook 1 <sup>st</sup> only	2,3 Kg	4,5 Kg	11,3 Kg.	18,1 Kg	31,8 Kg	40,8 Kg
Pizza Dough, Thick (60% AR) * • ◆	Hook 1 <sup>st</sup> only	4,5 Kg.	9,1 Kg	18,1 Kg.	22,7 Kg	31,8 Kg	45,4 Kg.
Fondant Icing	Beater	2,7 Kg	5,4 Kg	8,2 Kg.	11,3 Kg	16,3 Kg	27,2 Kg
Cake	Beater	4,5 Kg	9,1 Kg	13,6 Kg	18,1 Kg	27,2 Kg	40,8 Kg
Pie Dough	Beater	4,5 Kg	8,2 Kg	12,2 Kg	15,9 Kg	22,7 Kg	31,8 Kg
Pasta, Basic Egg Noodle	Hook	1,4 Kg	2,3 Kg	3,6 Kg	7,7 Kg	15,9 Kg	22,7 Kg

**NOTE:** \*The mixer capacity depends on the moisture content of the dough. When mixing dough (pizza, bread, or bagels) check your AR%! %AR (% Absorption Ration) = Water weight divided by flour weight. The capacities listed above are based on flour at room temperature and 70°F water temperature.

Δ Maximum Mixing Time- 7 Minutes

- . If high gluten flour is used, reduce the batch size by 10%.
- ◆ If using chilled flour, water below 20<sup>o</sup> C, or ice, reduce batch size by 10%.
- 2<sup>nd</sup> speed should never be used on 50% AR or lower with the exception of Model SM-60HI. The SM-60HI requires a 50% reduction in batch size to mix in speed 2 with 50% AR dough

